

Flush-mounted Pressure Transmitter and Switch - PiezoSwitch PS -

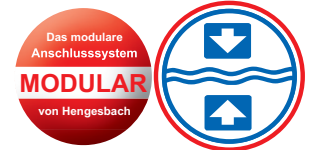

FEATURES

- **SIGNALOUTPUT 4...20mA, 2-L**
- **UP TO 2 PNP-SWITCHOUTPUTS, 24V DC, MAX. 50mA, WITH INDICATION**
- **LED-DISPLAY TO SHOW ACTUAL MEASURED VALUE**
- **SIMPLE OPERATION WITH 3 BUTTONS ONLY:
MENU SUPPORTED CONFIGURATION OF MEASURING RANGE AND SWITCHPOINTS DIRECTLY ON THE UNIT**
- **MEASURING RANGES FROM -1/0...30BAR, FREE PROGRAMMABLE, WITH TURNDOWN 4**
- **PROCESS CONNECTION:
G1" WITH SEALING CONUS AND UNIONNUT, WITHOUT ELASTOMERS, ADJUSTABLE.
ALTERNATIVELY EHEDG EL-ASEPTIC CERTIFIED MODULAR SYSTEM TYPE PZM WITH MORE THAN 8 DIFFERENT PROCESS ADAPTERS AND WELDING SOCKETS**

DESCRIPTION

The pressure transmitter PiezoSwitch is well suited for measuring absolute and relative pressure of fluids and gases in pipelines with temperature ranges from -40°C to 125°C. Two available switch outputs enable the switching functions.

The flush-mounted process connection PZM-type with o-ring-sealing and stainless steel diaphragm is certified EHEDG Type EL-ASEPTIC CLASS 1. It is ideal for measurements with highest hygienic demands and prescriptions. The PZM-Type connection comes with a wide range of adapters and reduces sustainably the cost of operation.

For applications without any elastomer-gaskets the metallic sealing and adjustable version K3 can be used.

The housing of the PiezoSwitch is complete of hygienic design. The pressure transmitter is resistant against overload of pressure and temperature and against CIP- and SIP applications.

The sensor measuring range of the piezoresistive and vacuum-tight sensor with stainless steel diaphragm is from -1/0...1bar up to -1/0...30bar.

Flush-mounted Pressure Transmitter and Switch - PiezoSwitch PS -



TECHNICAL DATA

General details						
Device type / measuring principle	PiezoSwitch PS / piezoresistive					
Input						
Measuring ranges [bar]	Relative	-1/0...1	-1/0...2,5	-1/0...5	-1/0...10	-1/0...30
	Absolute	0...1	0...2,5	0...5	0...10	0...30
	Overload protection	3	8	15	30	90
Setting the measuring ranges	with 3 keys within the transmitter					
Setting ranges	Measuring range begin zero	: 0...75%	of the sensor's nominal measuring span			
	Measuring span span	: 25...100%	of the sensor's nominal measuring span			
	Turndown (TD)	: 4				
Burst pressure DIN16086	≥ 4-fold nominal pressure range					
Output						
Output signal	2-wire: 4...20mA					
Fault signal	22mA					
Current limitation	21mA					
Signal range	3,8...20,5mA acc. Namur NE43					
Switch output	2x PNP, max. 50mA					
Measuring accuracy						
Reference conditions	acc. DIN IEC 770					
Linearity, hysteresis and repeatability as per the limit point method DIN IEC 770	≤ ± 0,5% of the sensor's nominal measuring range					
Activation time	< 2s (the device will carry out a self-test)					
Setting time	< 1s					
Long-time drift	≤ 0,2% of the span per year					
Thermal hysteresis	≤ ± 0,2% of the sensor's nominal measuring range / 10K (+20...+80°C) from 10...30bar ≤ ± 0,3% of the sensor's nominal measuring range / 10K (+20...+80°C) from 1...5bar					
Conditions of use						
Installation position / calibration position	Any position / standing vertically					
Medium temperature	-40...+125°C / 140°C 1 h					
Ambient storage temperature	-10...+85°C (below -20°C danger of cable breakage)					
Protection class acc. to EN60529	IP 67 and IP 69K					
Electromagnetic compatibility	acc. to EN 61326-1					
Construction						
Electrical connection	Round plug-in connector M12x1, 5-pole, nickel-plated brass (stainless steel available on request)					
Process connection	- Membrane, flush-welded, CrNiSt - EHEDG Typ EL-ASEPTIC CLASS 1 certified connection system PZM with press screw M38x1.5 and elastomer sealing - Process seal EPM (FDA-conform) (range -20...+150°C) - G1" with metallic sealing conus and union nut, adjustable (K3)					
Materials	- Field housing / lid: CrNiSt 1.4301 (304) - Housing seal: FPM (Viton®) - Pressure compensation element: Polyamide - Process connection / connection adapter: CrNiSt 1.4404 (316L) - Process membrane: CrNiSt 1.4435/1.4404 (316L)					
Filling fluid	Silicon oil (FDA)					
Display and operation						
Display	4 units 7-segment display incl. decimal point, 2x status LED for switch point					
Operation	3-key concept					
Auxiliary energy resources						
Power supply / burden	24...30V DC, max. burden: 600 Ω					
Accessories PiezoSwitch PS						
Certificates	Declaration of conformity Material certificates acc. EN 10204 (on request) EHEDG-Certifikate (on request)					
Process connection adapter	See order information					

Flush-mounted Pressure Transmitter and Switch - PiezoSwitch PS -

DIMENSION DRAWINGS for PiezoSwitch Typ PSPZ (Processconnection PZM) (dimensions in mm)

EHEDG-ASEPTIC certified modular system PZM with press-screw und o-ring sealing

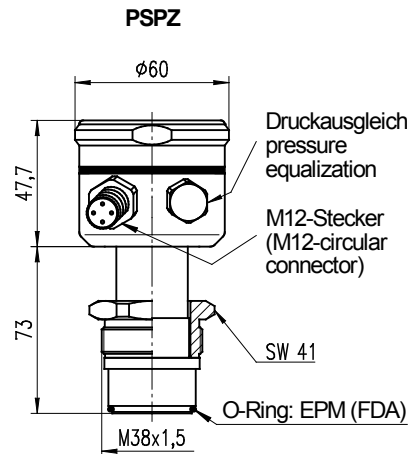

Prozessanschlussadapter: (optional mit 3 Leckagebohrungen; weitere Ausführungen auf Anfrage)
adapters for process connection: (optional with 3 leakage holes; other constructions on request)

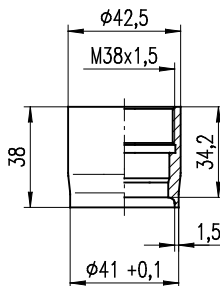

PEM9FPZM
Einschweißmuffe VPM - Rohr DN40
welding socket VPM - pipe DN40

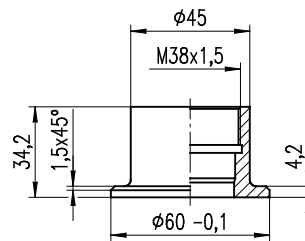

PEM4FPZM
Einschweißmuffe VPM Ø60 (Tank)
welding socket VPM Ø60 (tank)

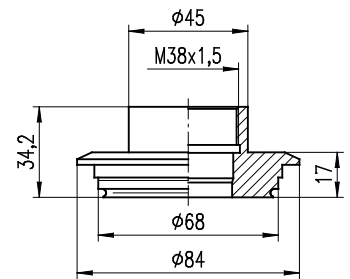

PVA6FPZM
VARIVENT-Flansch Ø68
VARIVENT-flange Ø68

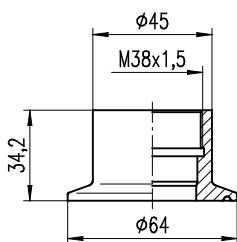

PCL5FPZM
Clamp DIN 32676 - DN50

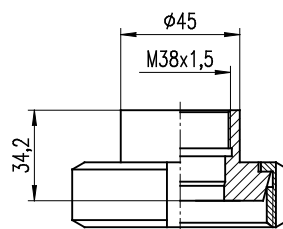

PMN...FPZM
Kegelstutzen DIN 11851
conical nozzle DIN 11851
DN40, DN50, DN65

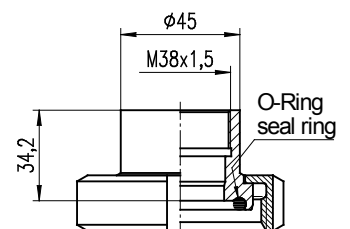

PBS...FPZM
Bundstutzen DIN 11864-1
Form A; DN40, DN50
collar nozzle DIN 11864-1
form A; DN40, DN50

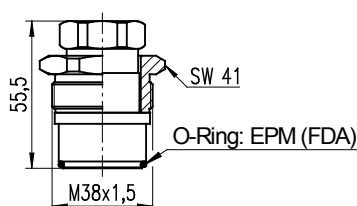

PVS1FPZM
Verschlussstopfen PZM
closing plug PZM

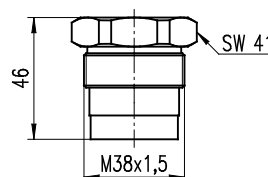

PED9FPZM
Einschweiß-Dummy PZM
welding dummy PZM

Flush-mounted Pressure Transmitter and Switch - PiezoSwitch PS -

DIMENSIONED DRAWINGS for PiezoSwitch Typ PSPZ (Processconnection PZM) (dimensions in mm)

Insertion thread ISO 228 - G1"; metallal sealing

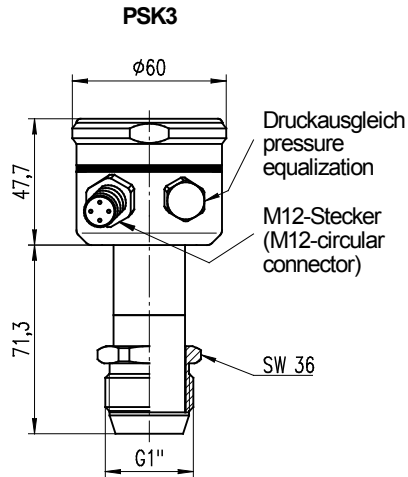

Prozessanschlussadapter: (optional mit 3 Leckagebohrungen; weitere Ausführungen auf Anfrage)
adapters for process connection: (optional with 3 leakage holes; other constructions on request)

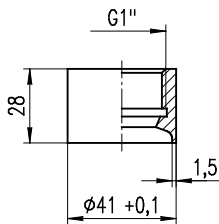

PEM2FPK3
Einschweißmuffe K3 - Rohr DN40
welding socket K3 - pipe DN40

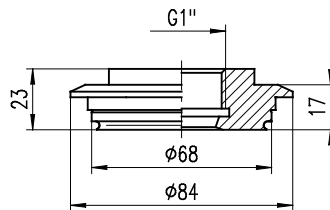

PVA6FPK3
VARIVENT-Flansch Ø68
VARIVENT-flange Ø68

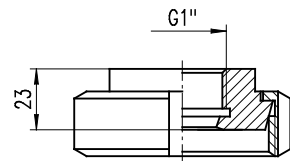

PMN5FPK3
Kegelstutzen DIN 11851 - DN50
conical nozzle DIN 11851 - DN50

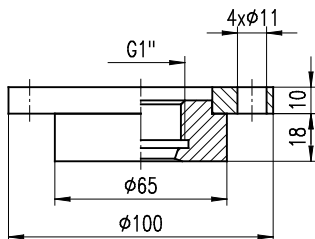

PDR6FPK3
DRD-Flansch Ø65
DRD-flange Ø65

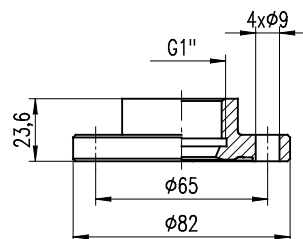

PBF4FPK3
Bundflansch DIN 11864 - DN40
collar flange DIN 11864 - DN40

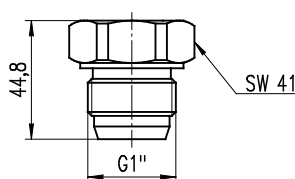

PVS1FPK3
Verschlussstopfen K3
closing plug K3

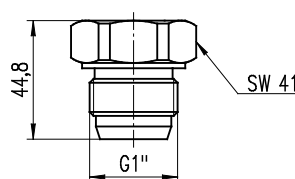

PED9FPK3
Einschweiß-Dummy K3
welding dummy K3

Flush-mounted Pressure Transmitter and Switch - PiezoSwitch PS -

ELECTRICAL CONNECTION

M12x1 roundplugin connector, 5-pole

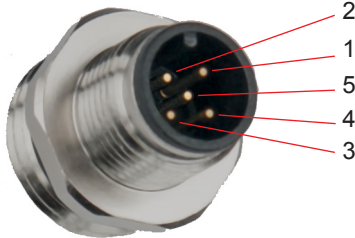

- 1 power supply +24VDC, loop current 4...20mA
- 2 output signal SP1, 50mA max.
- 3 Versorgung -24VDC, loop current 4...20mA
- 4 output signal SP2, 50mA max.
- 5 electrical grounding (only to be used if not grounded on site)

CONNECTION DIAGRAMM

Connection with existing grounding on site – the shielding of the connection wire is connected with the M12-plug.

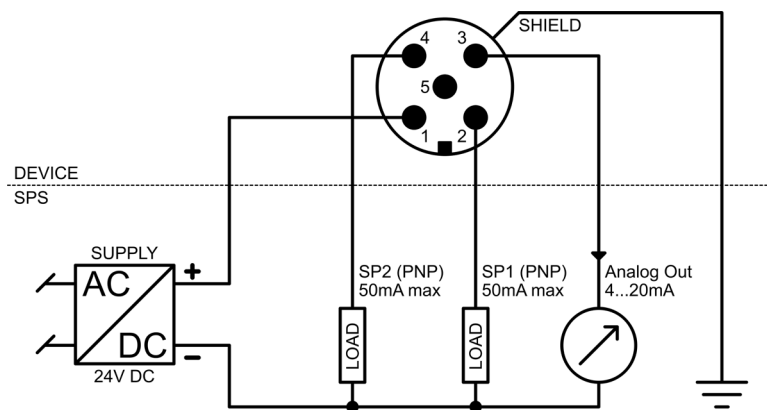

Connection with no grounding on site – the earth potential is carried along to the cablewire through Pin 5.

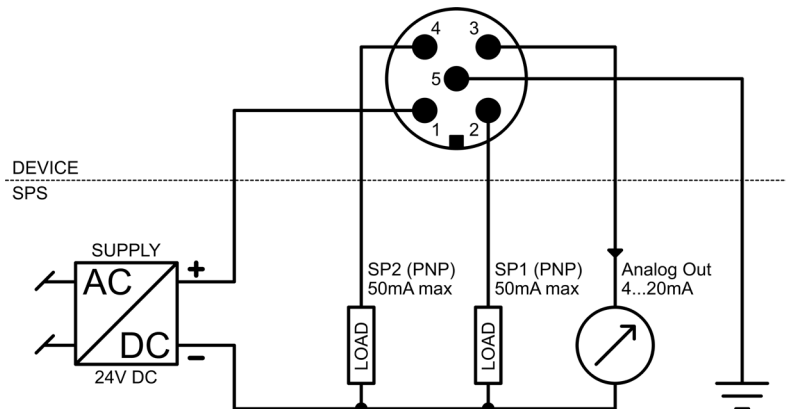

Flush-mounted Pressure Transmitter and Switch - PiezoSwitch PS -



ORDER INFORMATION for PiezoSwitch (PS)

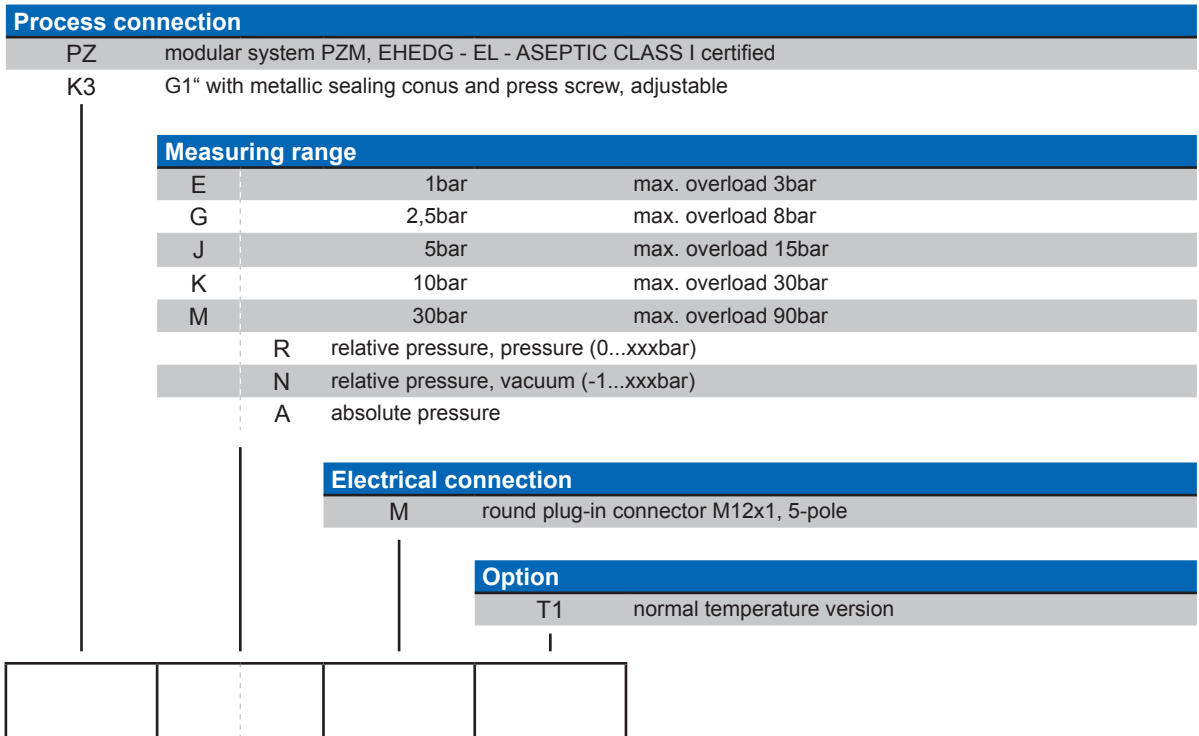

ORDER EXAMPLES

PiezoSwitch with prozess connection PZM and measuring cell 1bar relative PS PZ ER MT1

PiezoSwitch with prozess connection K3 and measuring cell 10bar absolute PS K3 KA MT1

ORDER INFORMATION for PiezoSwitch (PS) (please order separately)

Accessories/assembly parts	Article number
O-ring 28x2.5 made of EPM (FDA), set consisting of 10 x article BT-ORD 28x2,5 EPM (FDA)	P-POR1FPZM
O-ring 28x2.5 made of FKM (FDA), set consisting of 10 x article BT-ORD 28x2,5 FKM (FDA)	P-POR2FPZM

Flush-mounted Pressure Transmitter and Switch - PiezoSwitch PS -

ORDER INFORMATION for accessories PiezoSwitch PSPZ (Process connection PZM) (please order separately)

Item no.: Z-PEM9FPZM



Weld-in plug PEM9FPZM
Weld-in plug for modular process connection PZM for welding in tubes
DIN11850 row 2, DN40
material ss 1.4404 (316L)

Item no.: Z-PEM4FPZM



Weld-in plug with welding sleeve for modular process connection PZM for welding in tanks
material SS 1.4404 (316L)

Item no.: Z-PVA6FPZM

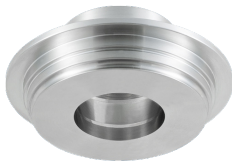

PZM process adapter VARIVENT® d=68mm for DN 40-125
universal adapter for modular process connection PZM
VARIVENT®-flange d=68mm
PN40 f. tubes DN40-125
material ss 1.4404 (316L)
- no gasket -

Item no.: Z-PCL5FPZM



Adapter Clamp DIN 32676 DN50
universal adapter for modular process connection PZM
clamp DIN32676 DN50
material ss 1.4404 (316L)
- no gasket and clamp-

Item no.: Z-PMN4FPZM / Z-PMN5FPZM / Z-PMN6FPZM



Conical process adapter with union nut DIN 11851, DN40; PN40 / DN50; DN60; PN25
universal adapter for modular process connection PZM
material ss 1.4404 (316L)

Item no.: Z-PBS4FPZM



Process adapter DIN 11864-1, DN40 form A for Tubes DIN 11866, row A (DIN11850)
universal adapter for modular process connection PZM, female union with union nut
DIN11864-1, DN40/PN25
material ss 1.4404 (316L)

Item no.: Z-PVS1FPZM



Sealing plug for modular process connection PZM with thrustbolt and o-ring gasket EPM (FDA)
material ss 1.4404 (316L)

Item no.: Z-PED9FPZM



Weld-in dummy for modular process connection PZM
brass material 2.0401

Flush-mounted Pressure Transmitter and Switch - PiezoSwitch PS -

ORDER INFORMATION for accessories PiezoSwitch PSPZ (Process connection PZM) (please order separately)

Item no.: **Z-PEM2FPK3**



Weld on socket PEM2FPK3 for tubes DIN 11850 - row 2 - DN40
for pressure transmitters with process connection type K3, with gasket free metal sealing conus, material ss 1.4404 (316L)

Item no.: **Z-PVA6FPK3**

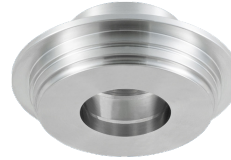

K3 process connector VARI-VENT® d=68mm for DN 40-125
process adapter for pressure transmitters with process connection type K3
VARI-VENT®-Flansch d=68mm PN40 f. tubes DN40-125 material ss 1.4404 (316L)
- no gasket -

Item no.: **Z-PMN5FPK3**

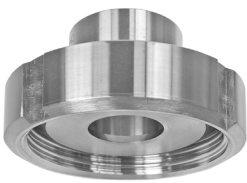

Connical pressure adapter with union nut DIN 11851, DN50
process adapter for pressure transmitters with conical connection type K3 with union nut DIN 11851, DN50; PN25 material ss 1.4404 (316L)

Item no.: **Z-PVS1FPK3**



Sealing plug for process connection K3 with G1"-thread and metallical sealing conus
material ss 1.4404 (316L)

Item no.: **Z-PED9FPK3**



Weld-in dummy for process connection type K3 with G1"-thread and metallical sealing conus
brass material 2.0401

Please observe the permissible nominal pressure of the process connection selected.
All specifications and certifications specified are only guaranteed when Hengesbach original components are used.
It is up to the system operator to ensure that the materials are compatible with the process conditions and the peripherals.
The devices are not suitable for use in potentially explosive areas and safety-related system components (SIL).
Our devices are subject to constant development; subject to technical modification.